

Capítulo 16 (Earthquake) Terremoto

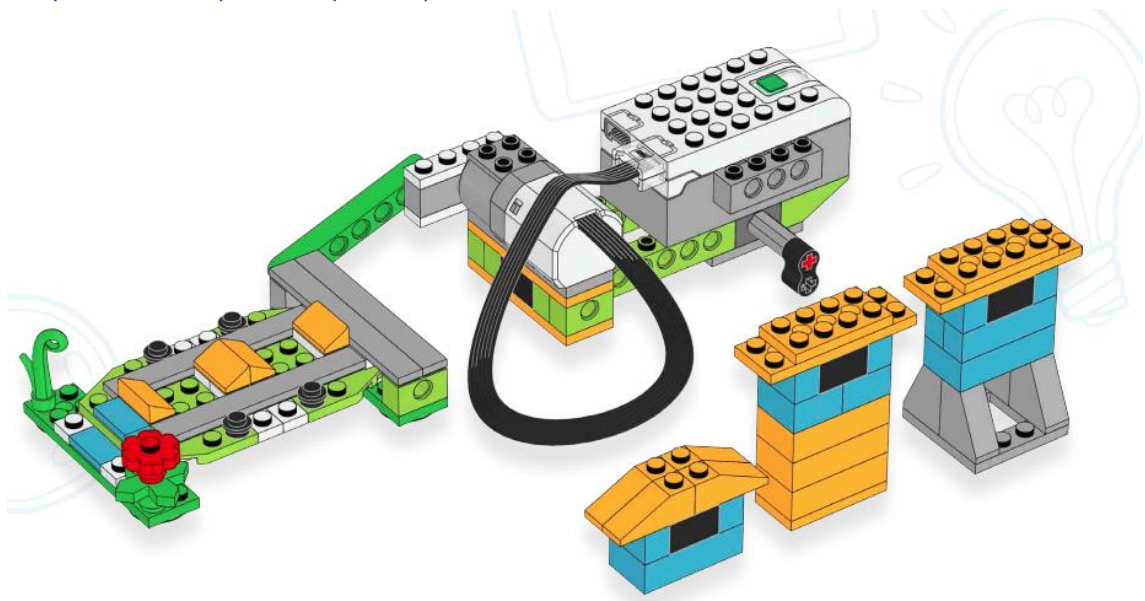

Para la realización de este capítulo necesitaremos un Kit.

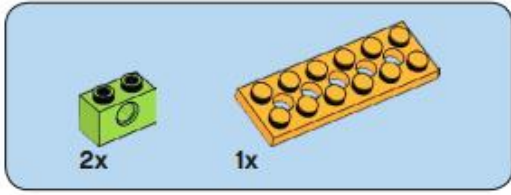

1

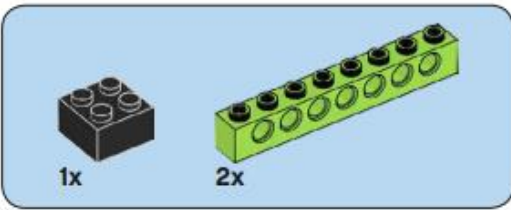
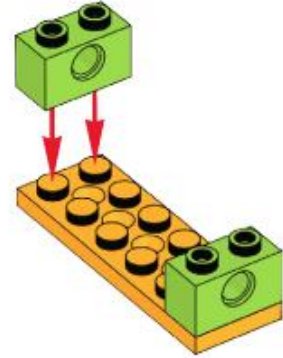

2

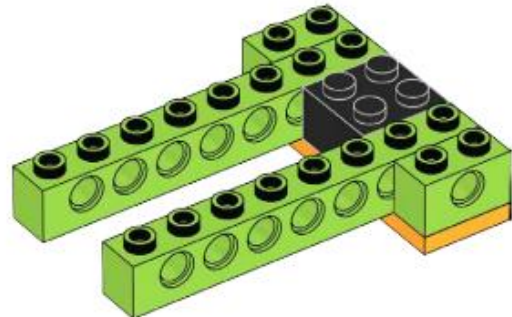

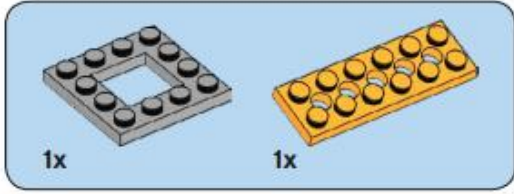

3

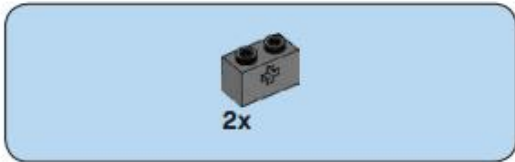
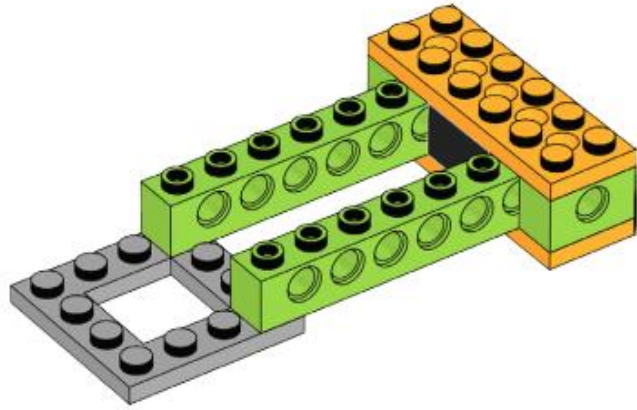

4

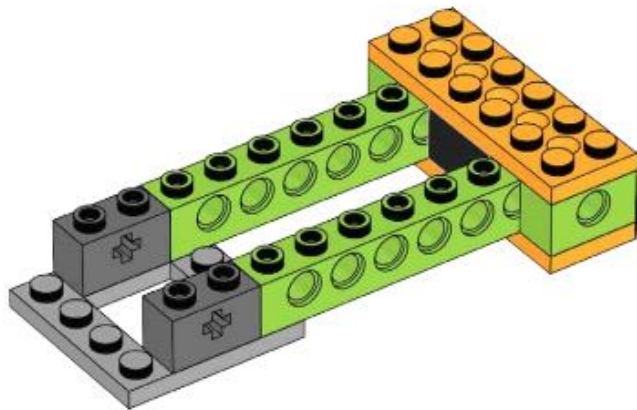

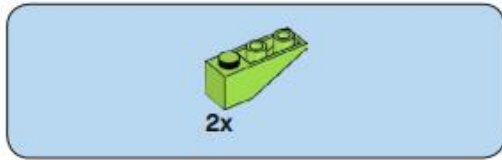

5

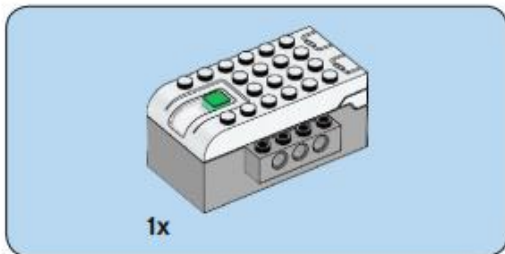
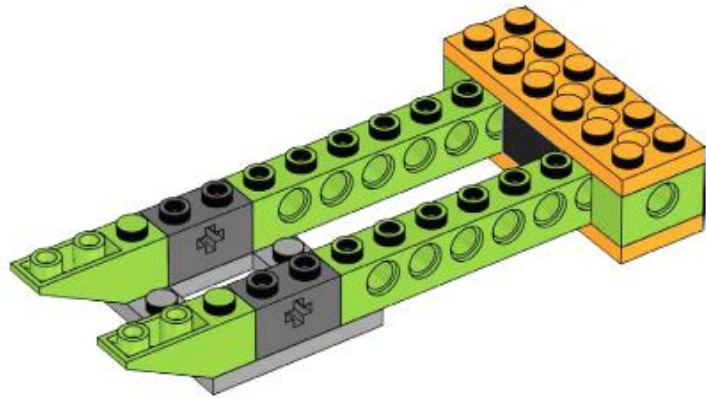

6

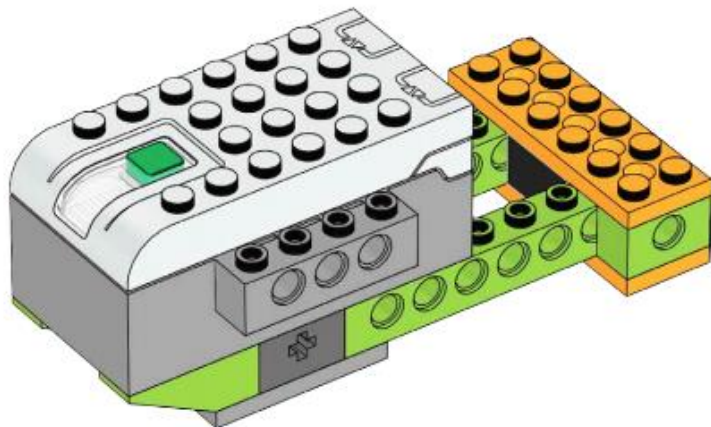

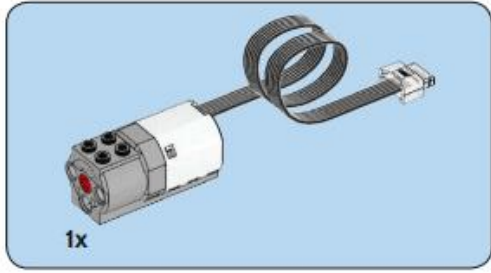

7

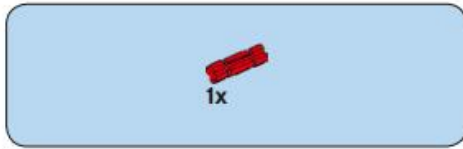
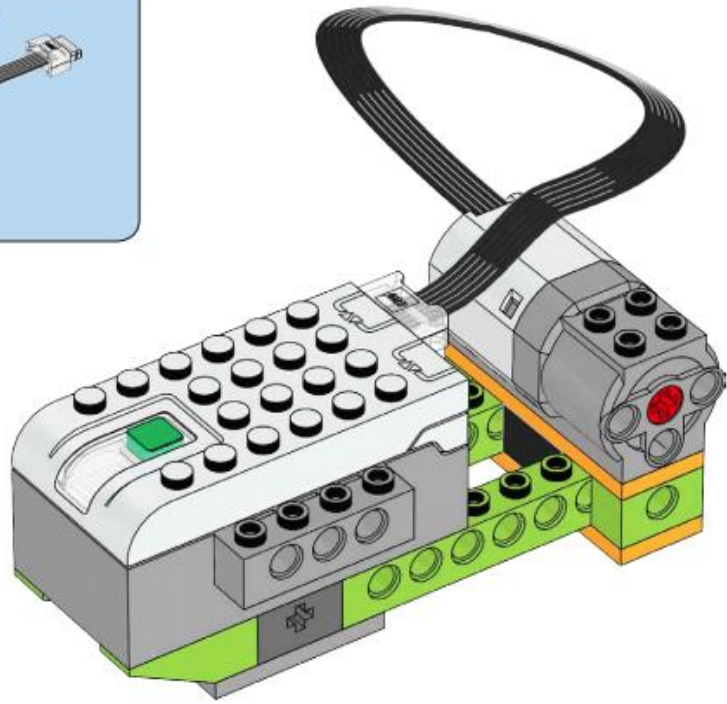

8

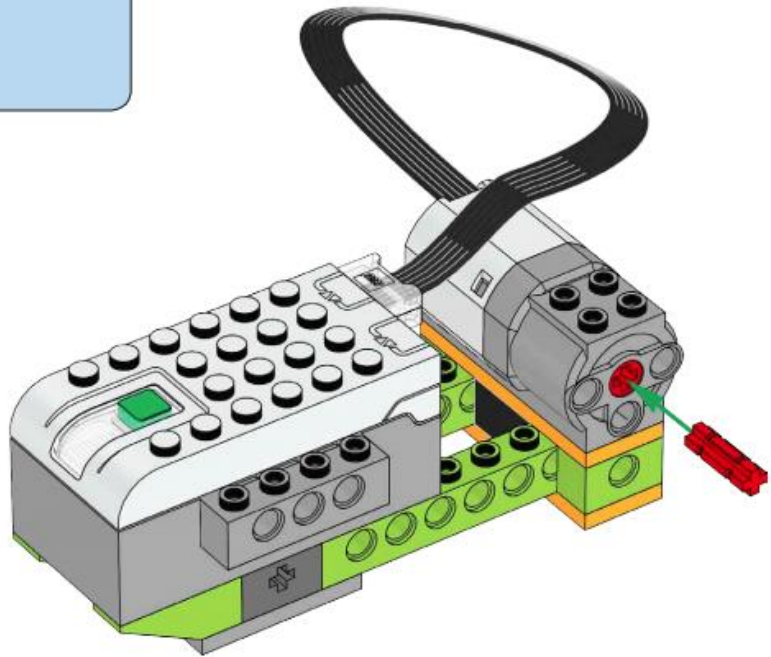



9

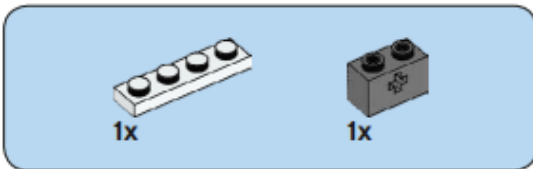
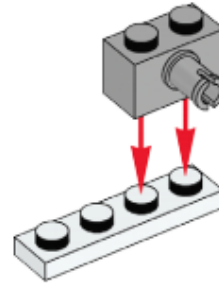

10

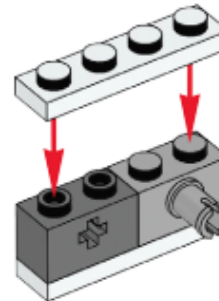

11

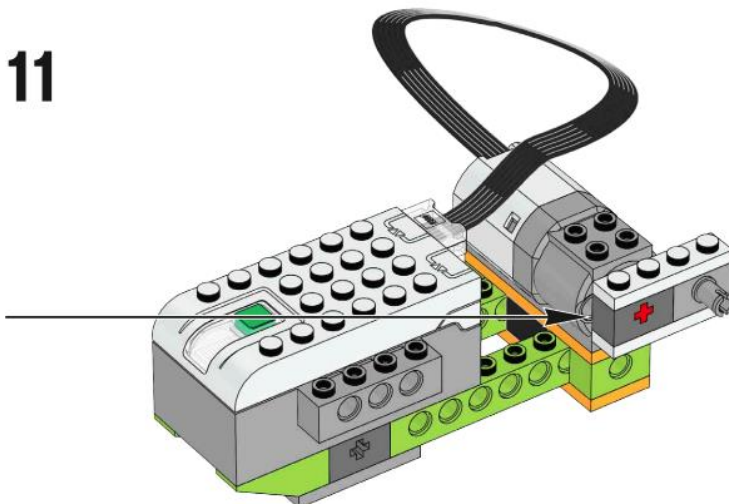

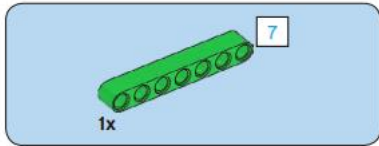

12

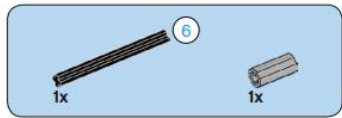
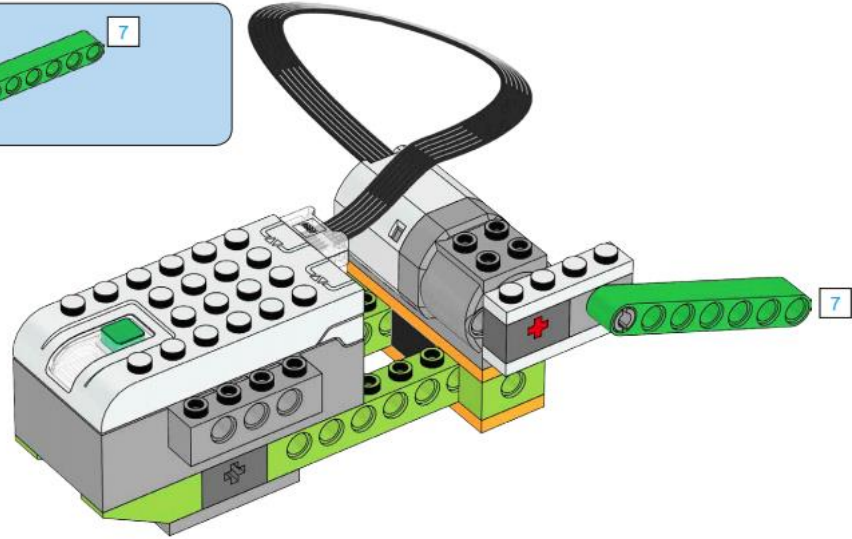

13

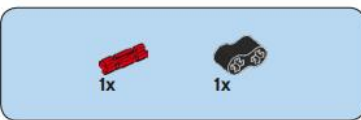
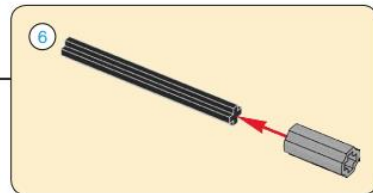
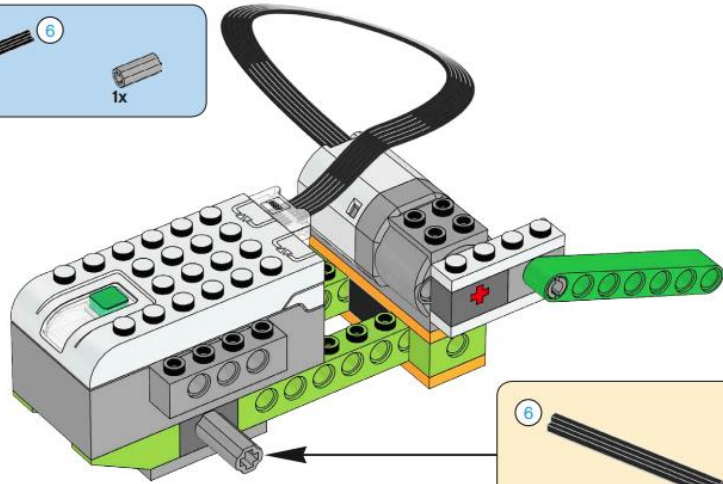

14

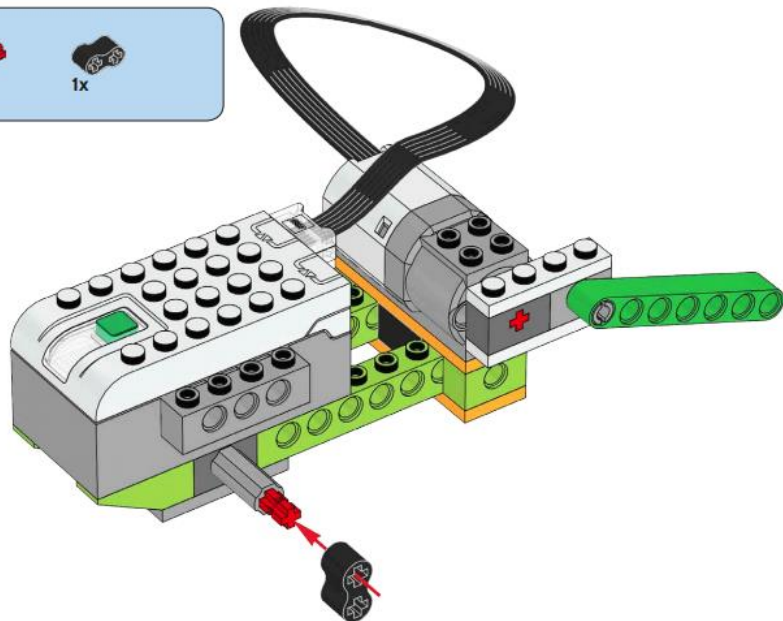

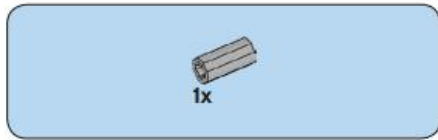

15

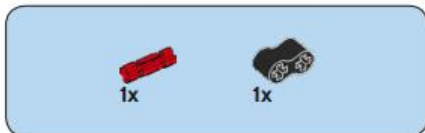
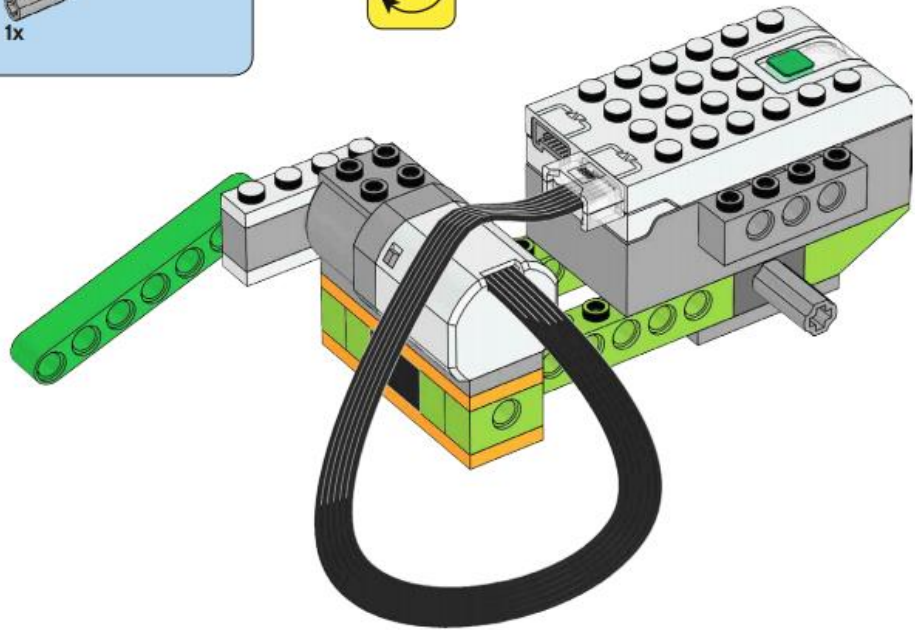

16

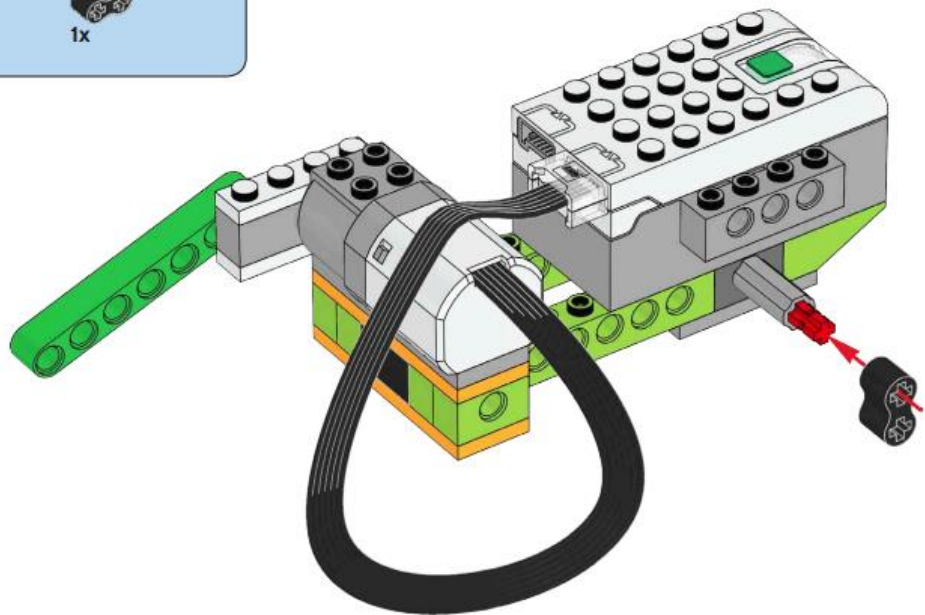

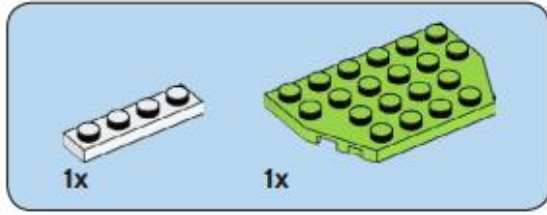

17

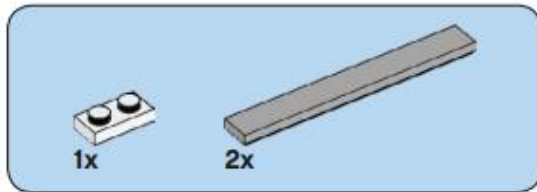
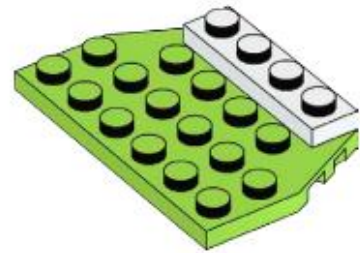

18

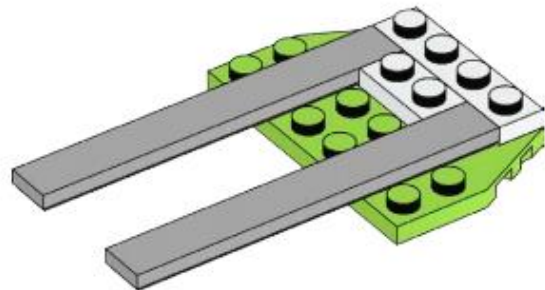

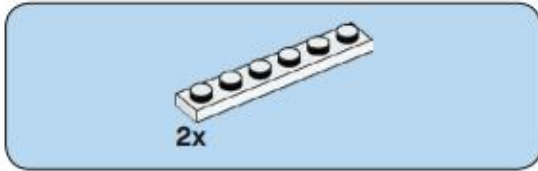

19

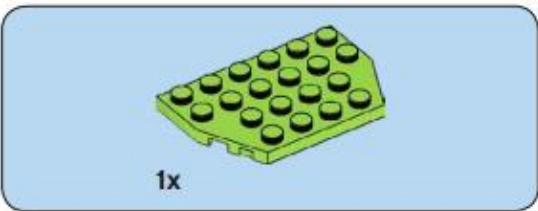
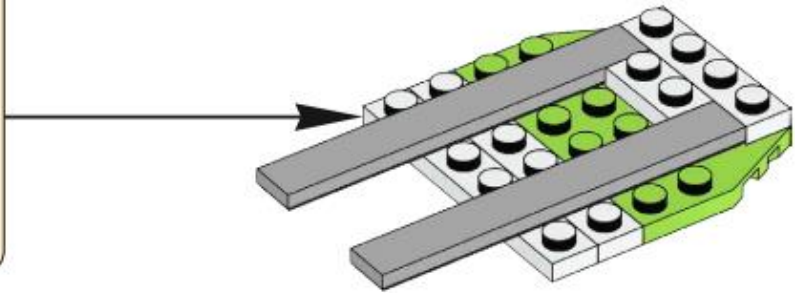
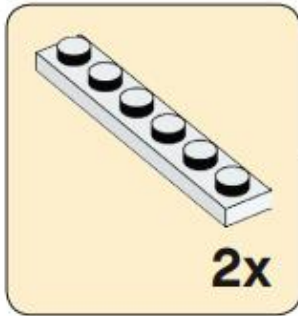

20

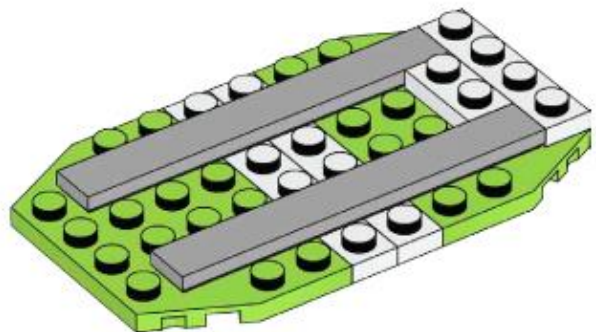

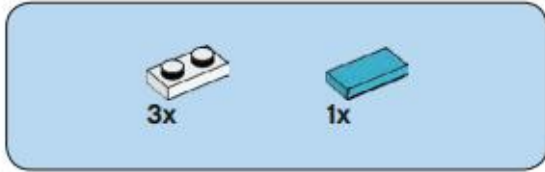

21

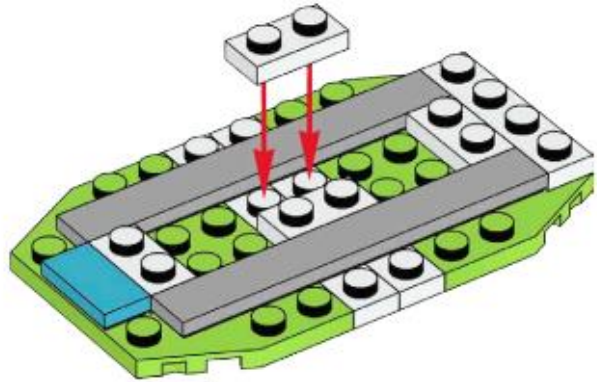

22

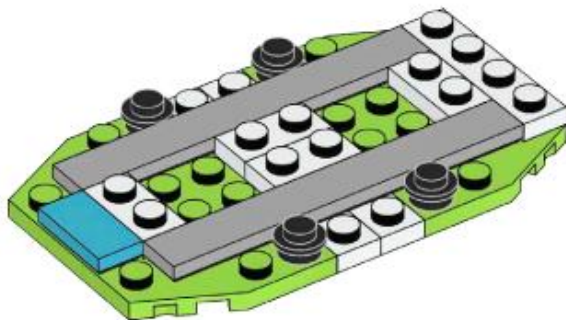

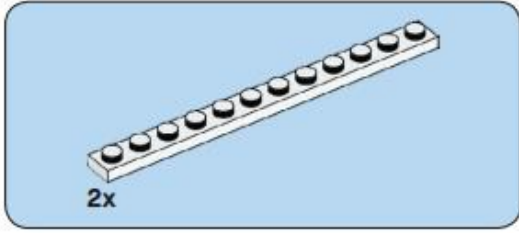

23

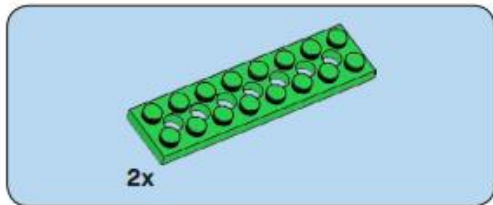
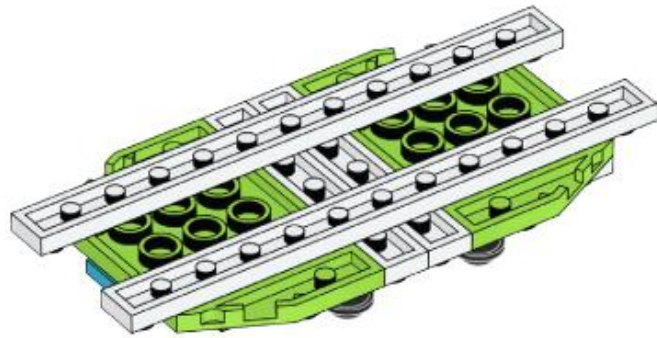

24

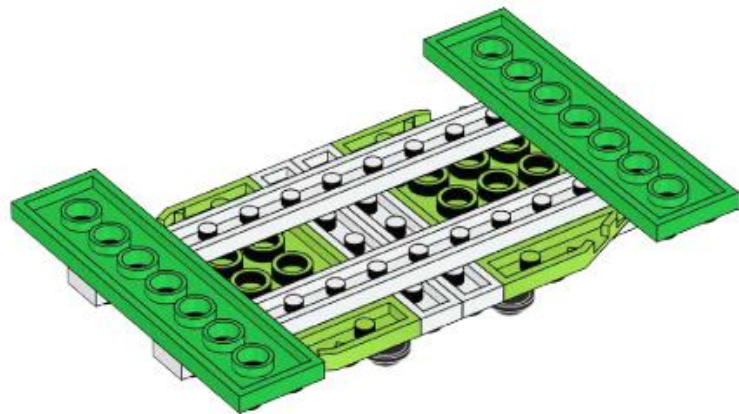

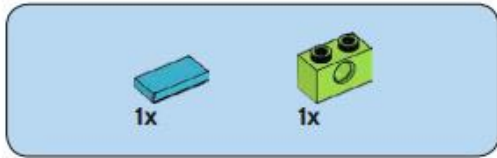

25

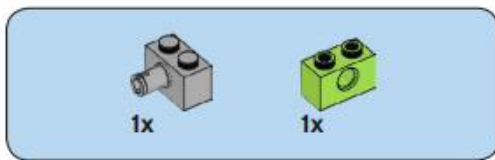
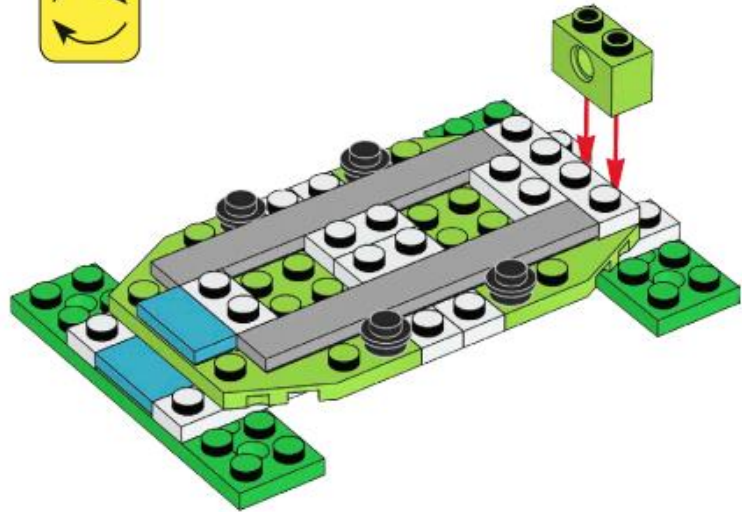

26

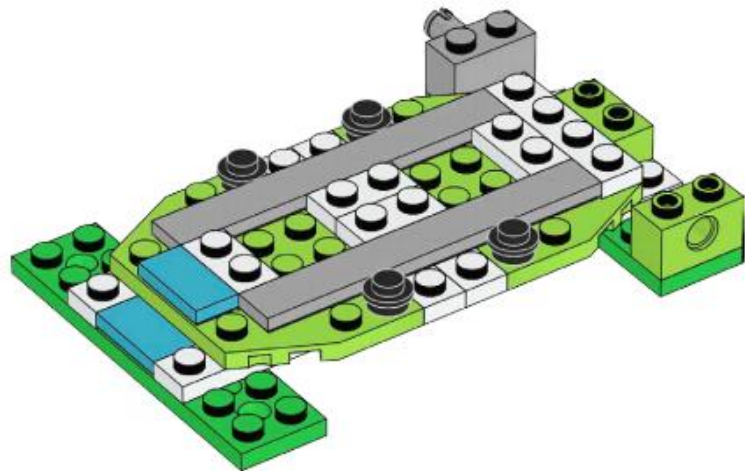

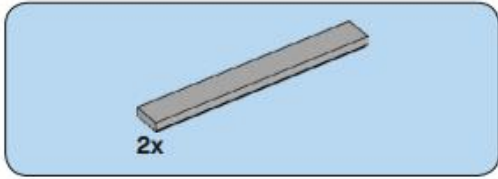

27

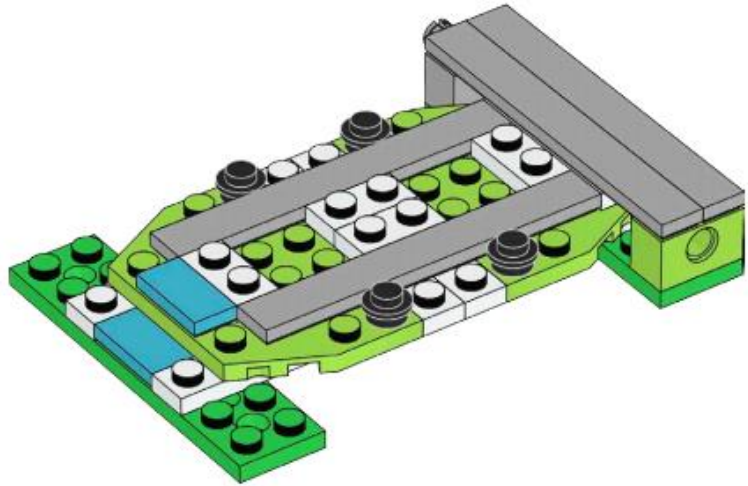

28

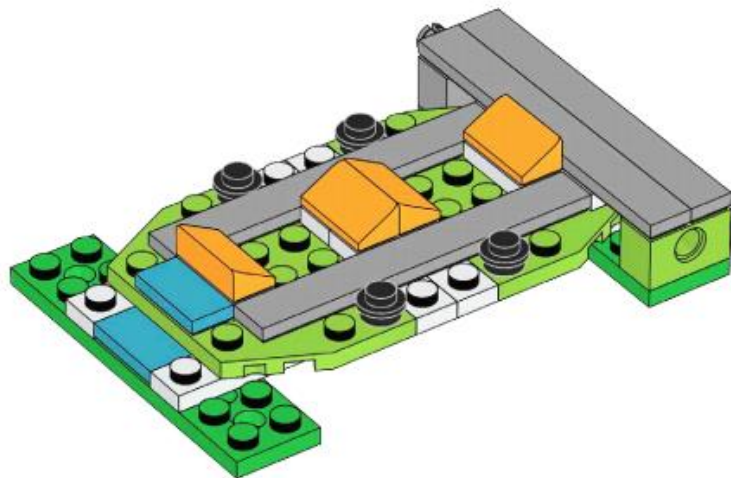



29

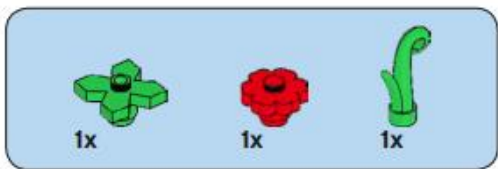
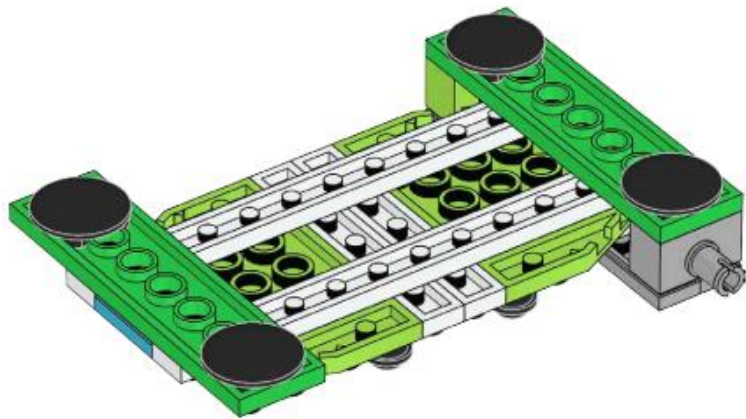

30

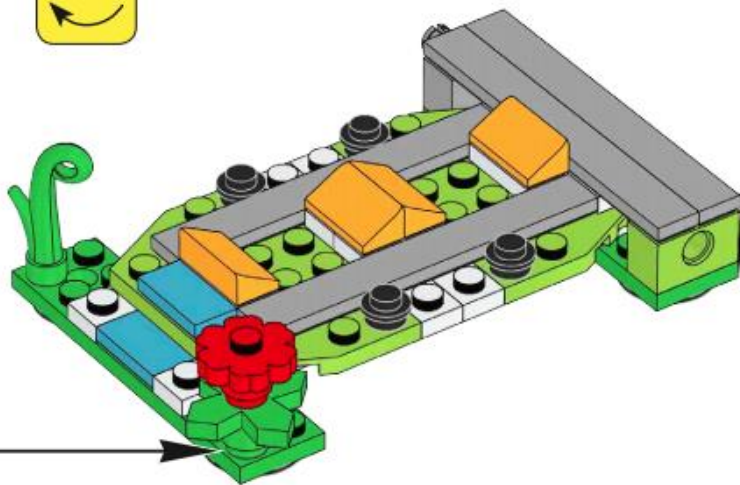

31

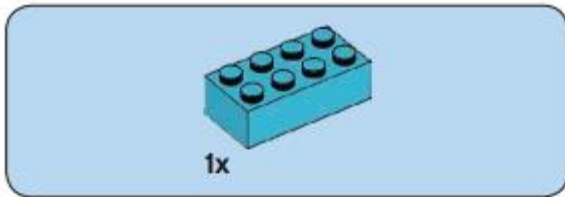
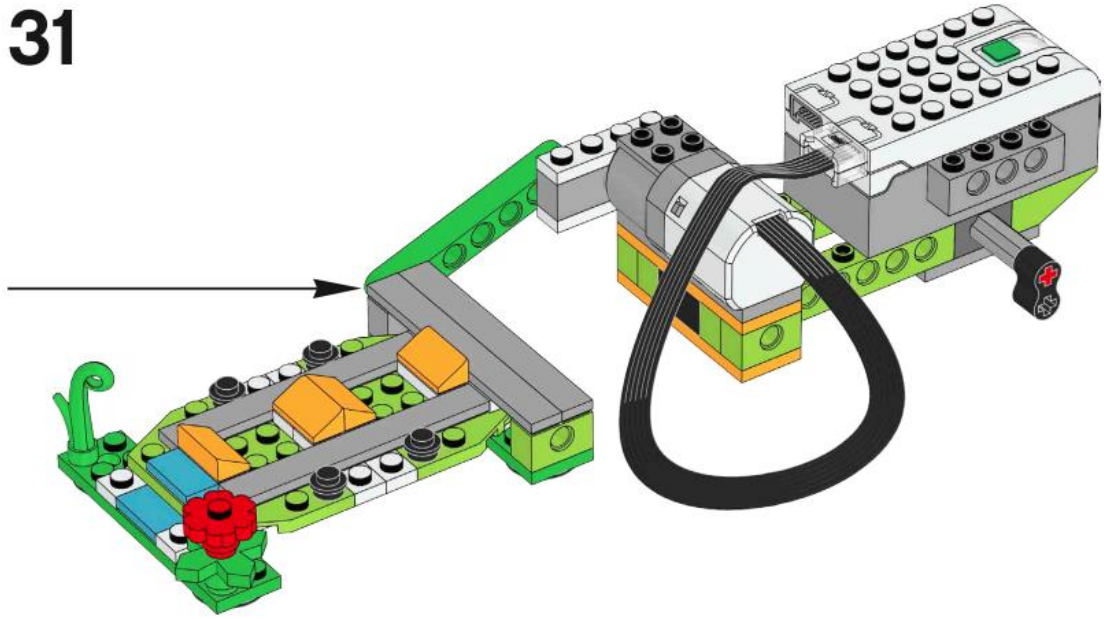

32

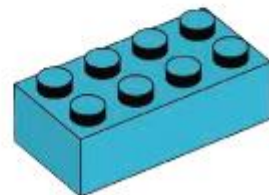

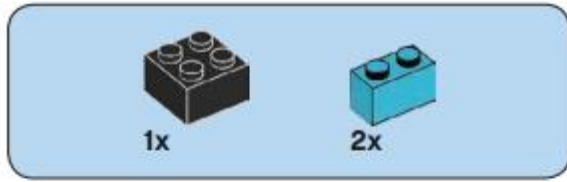

33

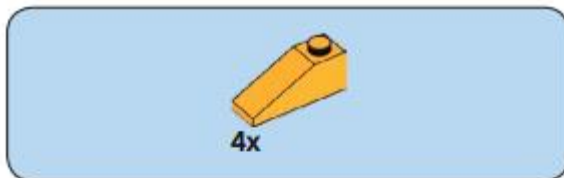
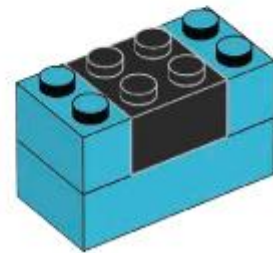

34

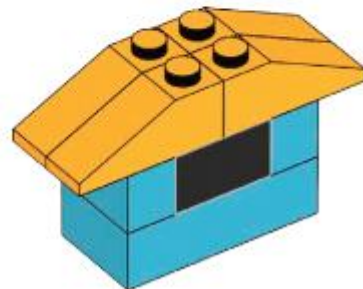

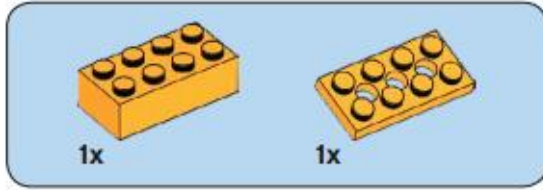

35

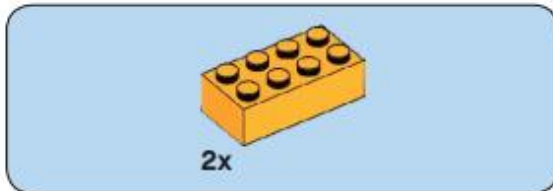
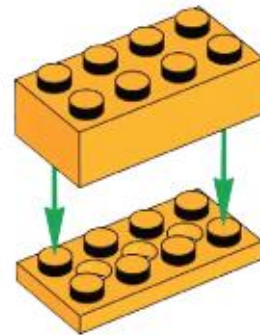

36

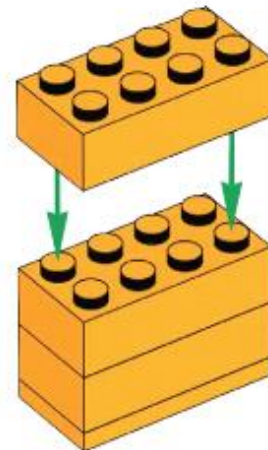

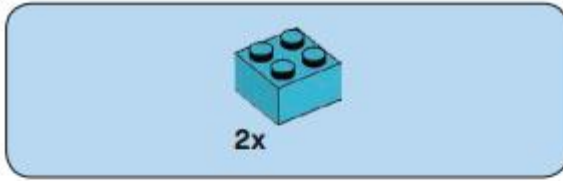

37

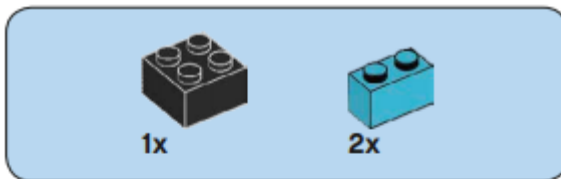
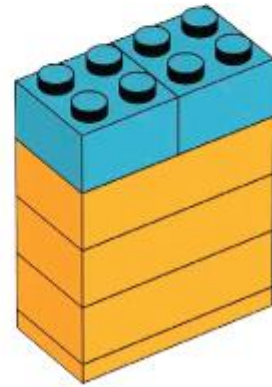

38

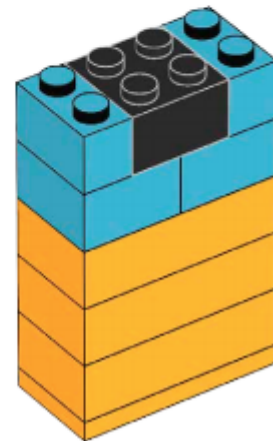

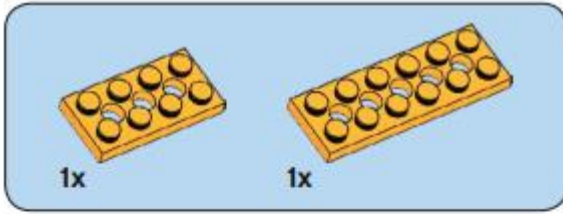

39

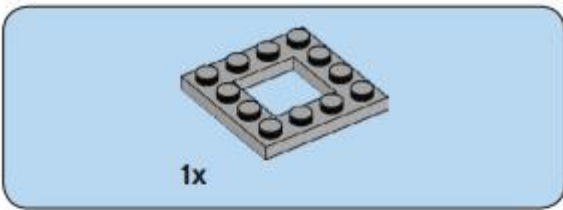
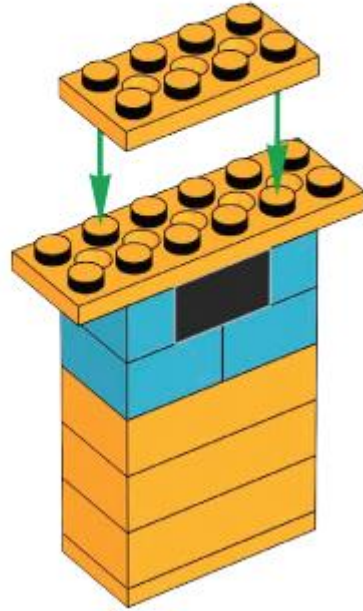

40

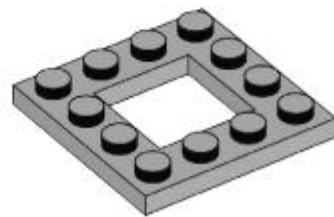

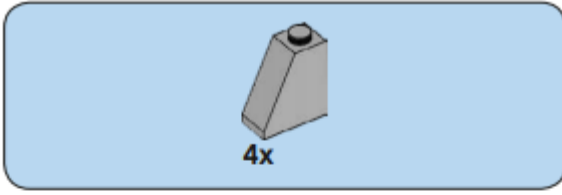

41

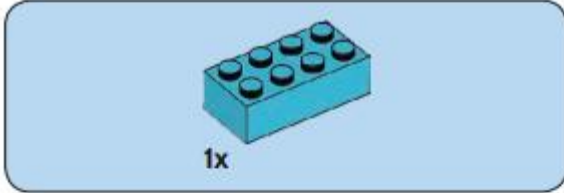
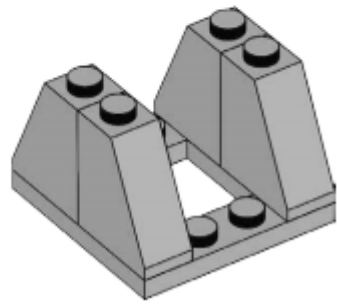

42

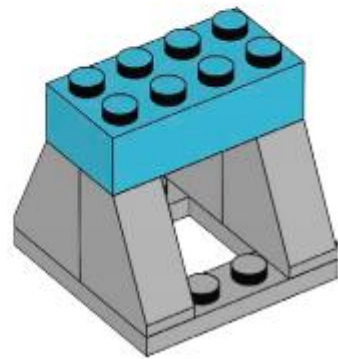

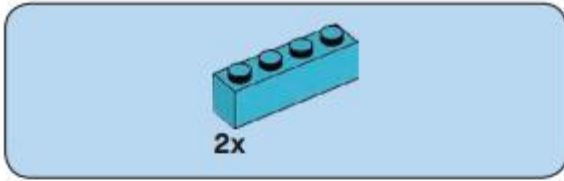

43

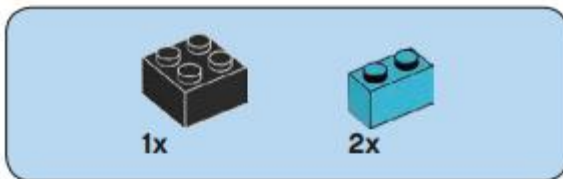
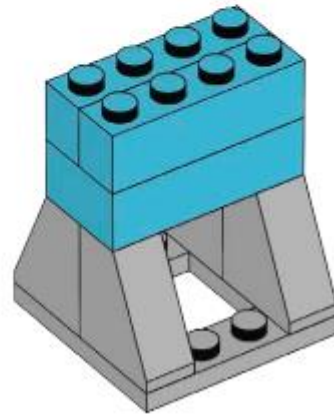

44

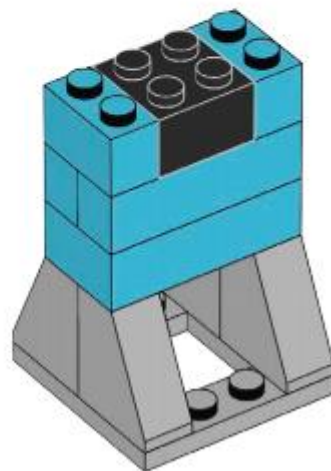

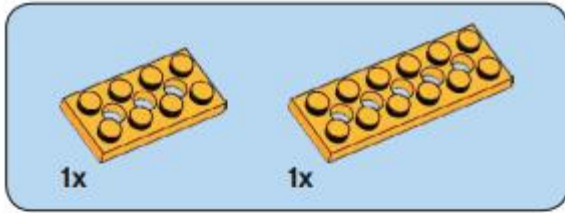

45

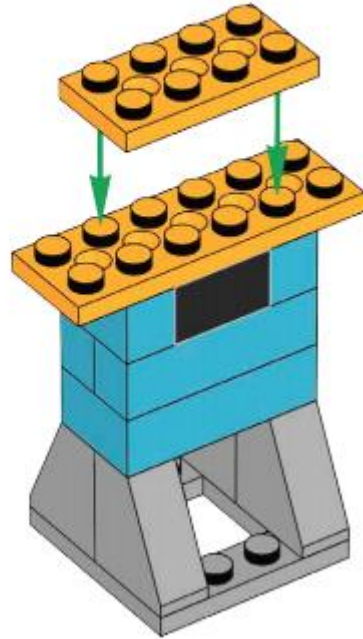

46

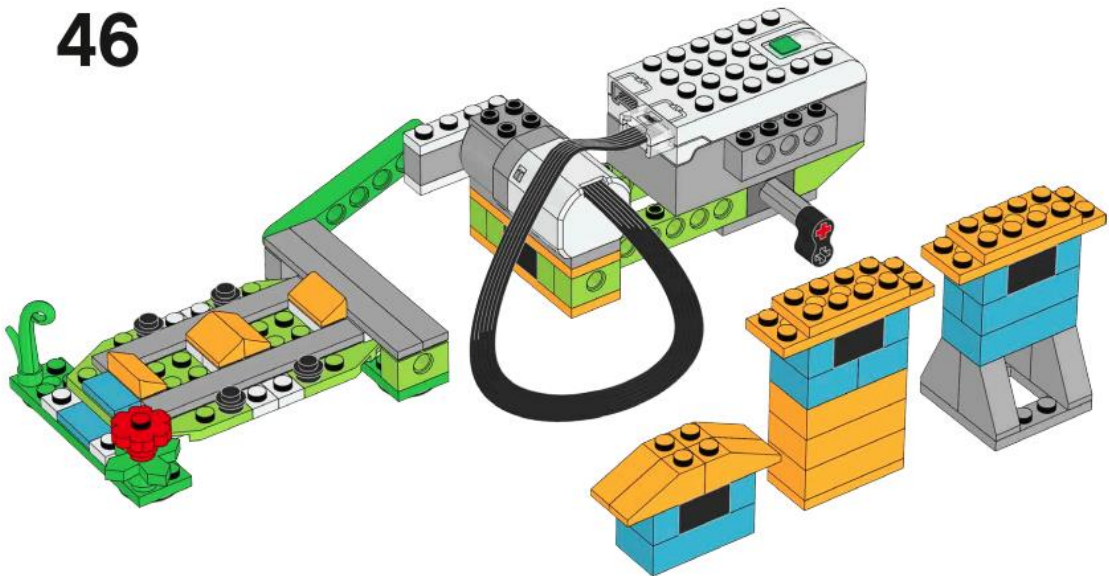

Codificación



En pantalla de lego WeDo observarás la potencia del motor y podrás ver a que potencia se cae cada objeto.

